

ROCK COUNTY, WISCONSIN



Board of Supervisors
51 S. Main Street
Janesville, WI 53545
Phone: 608/757-5510
FAX: 608/757-5511
www.co.rock.wi.us

**ROCK COUNTY BOARD OF SUPERVISORS' MEETING
THURSDAY, SEPTEMBER 23, 2010 – 6:00 P. M.**

**COUNTY BOARD ROOM/COURTROOM H
FOURTH FLOOR/COURTHOUSE EAST**

Agenda

1. CALL TO ORDER
2. INVOCATION & PLEDGE OF ALLEGIANCE
3. ROLL CALL
4. ADOPTION OF AGENDA
5. APPROVAL OF MINUTES – September 9, 2010
6. PUBLIC HEARING
7. CITIZEN PARTICIPATION, COMMUNICATIONS AND ANNOUNCEMENTS
8. NOMINATIONS, APPOINTMENTS AND CONFIRMATION
 - A. Appointments to Emergency Medical Services Advisory Council
9. INTRODUCTION OF NEW RESOLUTIONS OR ORDINANCES BY SUPERVISORS FOR REFERRAL TO APPROPRIATE COMMITTEE
10. REPORTS
11. UNFINISHED BUSINESS
12. NEW BUSINESS
 - A. Supplementary Appropriations and Budget Changes - Roll Call
 1. Authorizing Acceptance of Justice and Mental Health Collaboration Grant Program Funds, Amending the 2010 Budget, and Authorizing Contract
 2. Accepting High Intensity Drug Trafficking Area (HIDTA) Grant and Amending the Sheriff's Budget

NOTE: Item 12.A.1. and 12.A.2. will be considered by the Public Safety & Justice Committee on 9/20/10

 3. Application and Acceptance of Wisconsin Department of Natural Resources County Fish and Game Project Grant Funds

ROCK COUNTY BOARD OF SUPERVISORS

September 23, 2010

Page 2

12. NEW BUSINESS

- B. Bills Over \$10,000 - No Roll Call
- C. Encumbrances Over \$10,000 - Roll Call
- D. Contracts – Roll Call

- 1. Awarding Contract for Skylight/Masonry Wall Replacement and Tuck-Pointing at the Wells Cultural Center on the UW-Rock Campus
- 2. Awarding Contract for Courthouse Parking Structure Caulking and Repair

NOTE: Item 12.D.1. and 12.D.2. will be considered by the General Services Committee on 9/21/10

- 3. Agreements by and Between the Wisconsin Department of Transportation and Rock County for the Construction and Maintenance of Bicycle/Pedestrian Path Within the Rights-of-Way of State Highway 26 in Rock County
- 4. Awarding Contract for Prescription Benefit Manager

- E. Authorizing Submission of Project Safe Neighborhoods Grant Application
- F. Replacement of 911 Center Back-Up Telephone System

NOTE: Item 12.E. and 12.F. will be considered by the Public Safety & Justice Committee on 9/20/10

- G. Recognizing Efforts of the Friends of Beckman Mill, Incorporated, at Beckman Mill County Park on Their 20th Anniversary

- H. Honoring John and Mark Finnegan for Organizing the “VetsRoll” Project for WW II Veterans

NOTE: Item 12.H. will be considered by the Education, Veterans and Aging Services Committee on 9/21/10

- I. Review of WCA Resolutions

13. ADJOURNMENT

APPOINTMENTS TO EMERGENCY MEDICAL SERVICES ADVISORY COUNCIL

POSITION: Members of the Emergency Medical Services Advisory Council

AUTHORITY: County Board Resolution #96-9A-071

TERM: Three Years Expiring September 30, 2013

PER DIEM: For County Board Supervisors Only
Yes, Per Board Rule IV.J.

PRESENT MEMBERS:

Gary Groelle	John Rindfleisch
Shirley Connors	Jeff Ropicky
Ivan Collins	Kristina Jordan
Dennis Ahrens	

CONFIRMATION: Yes, by County Board of Supervisors

NEW APPOINTMENTS:

Jude Maurer, Captain Rock County Sheriff's Office 200 E. US Hwy. 14 Janesville, WI 53545	John Rindfleisch Clinton Fire Dept./EMS P.O. Box 153 Clinton, WI 53525
Shirley Connors Rock Co. Emergency Mgmt. 3530 N. Co. Hwy. F Janesville, WI 53545	Jeff Ropicky, VP Operations Curtis Ambulance 2423 W. Lisbon Ave. Milwaukee, WI 53205
Ivan Collins Public Safety & Justice Comm. 2110 Dupont Dr. Janesville, WI 53546	Kristina Jordan Blackhawk Tech. College P.O. Box 5009 Janesville, WI 53547-5009
Dennis Ahrens Town of Beloit Fire Chief 2445 Afton Road Beloit, WI 53511	

EFFECTIVE DATE: September 30, 2010

RESOLUTION NO. 10-9B-143

AGENDA NO. 12.A.1.(1)

RESOLUTION
ROCK COUNTY BOARD OF SUPERVISORS

Criminal Justice Coordinating Council
INITIATED BY



Elizabeth Pohlman McQuillen
DRAFTED BY

Public Safety & Justice Committee,
Finance Committee
SUBMITTED BY

September 13, 2010
DATE DRAFTED

AUTHORIZING ACCEPTANCE OF
JUSTICE AND MENTAL HEALTH COLLABORATION GRANT PROGRAM FUNDS,
AMENDING THE 2010 BUDGET, AND AUTHORIZING CONTRACT

1 WHEREAS, the U.S. Department of Justice, through the Bureau of Justice Assistance, has appropriated
2 funding for grants with the goal being to increase public safety through innovative cross-system
3 collaboration for individuals with mental illness and/or co-occurring mental health and substance use
4 disorders (MI/COD) who come into contact with the criminal justice system; and,
5

6 WHEREAS, Rock County submitted an application for a planning grant to conduct a full needs and
7 resource assessment and design a strategic, collaborative plan to initiate systemic change for the
8 identification and treatment of offenders with MI/COD in Rock County, in April 2010; and
9

10 WHEREAS, on September 8, 2010, Rock County's application was approved in the amount of \$62,569,
11 including \$50,000 in Federal Aid and \$12,569 in-kind services match; and,
12

13 WHEREAS, this planning grant, over 12 months beginning October 1, 2010, will be primarily used to
14 hire a consultant to conduct an intensive needs and resource assessment and visit best practice sites
15 with regard to MI/COD in the criminal justice system; and,
16

17 WHEREAS, strategic planning will focus on diverting non-violent adults and juveniles with MI/COD
18 from the justice system at the earliest point possible and providing them with the treatment they need to
19 reduce recidivism and become productive members of society; and,
20

21 WHEREAS, this grant will be managed programmatically, including administration of contracts under
22 this grant, by the Rock County Administrator's Office and fiscally by the Rock County Sheriff's
23 Office; and,
24

25 WHEREAS, a CJCC subcommittee will be established representing support from all levels of
26 government, justice, mental health and AODA treatment services, transportation, housing, advocates,
27 consumers, and family members. This collaboration will ultimately form the basis for a problem
28 solving model or strategic plan.
29

30 NOW, THEREFORE, BE IT RESOLVED that the Rock County Board of Supervisors duly assembled
31 this ____ day of _____, 2010 does hereby accept the Justice and Mental Health Collaboration
32 Program Grant funds in the amount of \$62,569 from the U.S. Department of Justice.
33

34 BE IT FURTHER RESOLVED, that the 2010 Rock County Sheriff's Office budget be amended as
35 follows:

<u>Account/Description</u>	<u>Budget at</u> <u>9/13/10</u>	<u>Increase</u> <u>(Decrease)</u>	<u>Amended</u> <u>Budget</u>
<u>Sheriff's Office</u>			
<u>Source of Funds</u>			
21-2220-0000-42100/ 42 Federal Aid	0	50,000	50,000

10-9B-143

44 Use of Funds
 45 21-2220-0000-63110/
 46 Administration Expense 0 50,000 50,000
 47
 48 **BE IT FURTHER RESOLVED**, that a contract is authorized for hiring the Janesville League of
 49 Women Voters to conduct two community roundtable meetings and four focus groups, as designated in
 50 the grant application, in the amount of \$1,200 during the grant period from October 1, 2010-September
 51 30, 2011.

Respectfully submitted,

PUBLIC SAFETY & JUSTICE COMMITTEE

 Ivan Collins, Chair

 Larry Wiedenfeld, Vice Chair

 Mary Beaver

 Hank Brill

 Brian Knudson

FINANCE COMMITTEE ENDORSEMENT

Reviewed and approved on a vote of 5-0

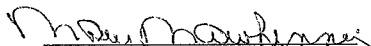
 Mary Mawhinney, Chair

ADMINISTRATIVE NOTE:

Recommended.

 Craig Knutson
 County Administrator

FISCAL NOTE:

This resolution authorizes the acceptance and expenditure of a \$50,000 Federal grant for the Mental Health Collaboration Program. The \$12,569 in-kind match is already included in the 2010 budget for staff costs associated with this program.

 Jeffrey A. Smith
 Finance Director

LEGAL NOTE:

The County Board is authorized to accept grant funds pursuant to sec. 59.52(19), Wis. Stats. As an amendment to the adopted 2010 County Budget, this Resolution requires a 2/3 vote of the entire membership of the County Board pursuant to sec. 65.90(5)(a), Wis. Stats. The County Board is authorized to take this action pursuant to §§ 59.01 and 59.51, Wis. Stats.

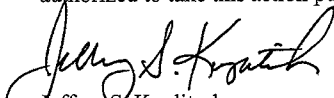
 Jeffrey S. Kuglitsch
 Corporation Counsel

Executive Summary

AUTHORIZING ACCEPTANCE OF JUSTICE AND MENTAL HEALTH COLLABORATION GRANT PROGRAM FUNDS, AMENDING THE 2010 BUDGET, AND AUTHORIZING CONTRACTS

The U.S. Department of Justice, through the Office of Justice Programs, Bureau of Justice Assistance, has authorized funding for grants through the Mentally Ill Offender Treatment and Crime Reduction Act of 2004 and the Mentally Ill Offender Treatment and Crime Reduction Reauthorization and Improvement Act of 2008. The goal of the grant is to increase public safety through innovative cross-system collaboration for individuals with mental illness or co-occurring mental health and substance use disorders (MI/COD) who come into contact with the criminal justice system.

On September 8, 2010, Rock County was awarded a \$50,000 planning grant to design a strategic, collaborative plan to initiate systemic change for the identification and treatment of offenders with MI/COD. The twenty percent match (of \$12,569) for which the County is responsible will come in the form of an in-kind personnel match, as opposed to any monetary expenditure by the county.

The planning grant requires development of an effective collaboration representing support from all levels of government, justice, mental health and AODA treatment services, transportation, housing, advocates, consumers, and family members. This collaboration will ultimately form the basis for a problem solving model, or strategic plan, to intercept individuals from the system at the earliest point possible while promoting public safety.

Strategic planning will focus on diverting non-violent adults and juveniles with MI/COD from the justice system at the earliest point possible and providing them with the treatment they need to reduce recidivism and become productive members of society. Specific objectives of the planning process are to determine what information should be tracked and how to create a system for tracking such data; enhance communication and coordination between justice entities, mental health providers, and AODA providers; increase diversion strategies for MI/COD offenders; and increase the number of justice personnel with knowledge about MI/COD. A cross-systems strategic plan will be designed to improve the nexus between the mental health, AODA, and justice systems.

**RESOLUTION
ROCK COUNTY BOARD OF SUPERVISORS**

Sheriff Robert D. Spoden
INITIATED BY



Diane Michaelis
DRAFTED BY

**Public Safety and Justice
Committee**
SUBMITTED BY

September 1, 2010
DATE DRAFTED

**Accepting High Intensity Drug Trafficking Area (HIDTA) Grant and
Amending the Sheriff's Budget**

1 **WHEREAS**, the Sheriff's Office has been awarded a \$50,000 grant from the High Intensity
2 Drug Trafficking Area (HIDTA) Program; and,
3

4 **WHEREAS**, the HIDTA Program is a program administered by the Office of National Drug
5 Control Policy (ONDCP); and,
6

7 **WHEREAS**, the purpose of the Program is to reduce drug trafficking and drug production in the
8 United States; and,
9

10 **NOW, THEREFORE, BE IT RESOLVED** by the Rock County Board of Supervisors duly
11 assembled this _____ day of _____, 2010 to approve and authorize the
12 acceptance of \$50,000 of HIDTA grant funds and to authorize the Sheriff to sign the award
13 documents; and,
14

15 **BE IT FURTHER RESOLVED**, that the 2010 Sheriff's budget be amended as follows:

<u>Account/ Description</u>	<u>Budget 09/01/10</u>	<u>Increase (Decrease)</u>	<u>Amended Budget</u>
<u>Source of Funds</u>			
21-2140-2009-46002	- 0 -	50,000	50,000
Other Grants and Contracts			
<u>Use of Funds</u>			
21-2140-2009-61210	- 0 -	30,000	30,000
Overtime Wages-Productive			
21-2140-2009-63908	- 0 -	8,000	8,000
Investigative Expenses			
21-2140-2009-67172	- 0 -	12,000	12,000
Capital Assets \$500-\$999			

10-9B-144

Accepting High Intensity Drug Trafficking Area (HIDTA) Grant and Amending the Sheriff's Budget

Page 2

Respectfully submitted,

Public Safety and Justice Committee

Absent
Ivan Collins, Chair

Larry Wiedenfeld
Larry Wiedenfeld, Vice Chair

Mary Beaver
Mary Beaver

Henry Brill
Henry Brill

Brian Knudson
Brian Knudson

Finance Committee Endorsement

Reviewed and approved on a vote of
5-0

Mary Mawhinney
Mary Mawhinney, Chair

FISCAL NOTE:

This resolution authorizes the acceptance and expenditure of a \$50,000 grant for the Sheriff's Drug Reduction Program. No County matching funds are required to accept this grant.

Jeffrey A. Smith
Jeffrey A. Smith
Finance Director

LEGAL NOTE:

The County Board is authorized to accept grant funds pursuant to sec. 59.52(19), Wis. Stats. As an amendment to the adopted 2010 County Budget, this Resolution requires a 2/3 vote of the entire membership of the County Board pursuant to sec. 65.90(50(a), Wis. Stats.

Jeffrey S. Kuglitsch
Jeffrey S. Kuglitsch
Corporation Counsel

ADMINISTRATIVE NOTE:

Recommended.

Craig Knutson
Craig Knutson
County Administrator

Accepting High Intensity Drug Trafficking Area (HIDTA) Grant and Amending the Sheriff's Budget
Page 3

Executive Summary

The Sheriff's Office has been awarded a \$50,000 grant from the High Intensity Drug Trafficking Area (HIDTA) Program, a program administered by the Office of National Drug Control Policy (ONDCP). The purpose of the Program is to reduce drug trafficking and drug production in the United States.

The HIDTA Program provides funding resources to joint initiatives of federal, state, local, and tribal agencies in each area designated as a HIDTA to carry out activities that address the specific drug threats of those areas.

The grant funds will be used for overtime, investigative expenses, and equipment. The equipment purchased will be used for observation and undercover operations. Specific equipment to be purchased has not been determined at this time.

Overtime	\$30,000
Investigative Expenses	\$8,000
Equipment	<u>\$12,000</u>
Total	\$50,000

**RESOLUTION
ROCK COUNTY BOARD OF SUPERVISORS**

Public Works Committee
Initiated by



Lori Williams, Parks Director
Drafted by

Public Works Committee
& Parks Advisory Committee
Submitted by

August 25, 2010
Date Drafted

**APPLICATION AND ACCEPTANCE OF WISCONSIN DEPARTMENT OF
NATURAL RESOURCES COUNTY FISH AND GAME PROJECT GRANT FUNDS**

1 WHEREAS, the legislature of the State of Wisconsin enacted legislation providing for allocation to
2 the respective counties in that state on an acreage basis for the county fish and game projects,
3 including conservation of resources and habitat, on the condition that the counties match the state
4 allocation; and,
5

6 WHEREAS, Rock County made application to participate in county fish and game projects
7 pursuant to provisions of s.23 09(12) of the Wisconsin Statutes and as authorized by county board
8 resolution; and,
9

10 WHEREAS, matching grant funds totaling \$2,027 are available from the Wisconsin DNR and a
11 resolution accepting the same is required; and,
12

13 WHEREAS, there are no costs for this grant as all labor was performed by volunteers and all
14 equipment and supplies were donated; and,
15

16 WHEREAS, funds received will be utilized at Magnolia Bluff Park to build a pathway around the
17 restoration project in order to avoid unnecessary disturbance of the restoration area.
18

19 NOW, THEREFORE, BE IT RESOLVED that the Rock County Board of Supervisors duly
20 assembled this ____ day of _____, 2010 does hereby approve the acceptance of these funds;
21 and,
22

23 BE IT FURTHER RESOLVED that the County Board Chair and the County Clerk are hereby
24 authorized and directed to sign the grant agreements and that these documents be submitted to the
25 Wisconsin Department of Natural Resources; and,
26

27 BE IT FURTHER RESOLVED, that the Parks Director be authorized to file all necessary
28 documents for administration and reimbursement of this program.
29

30 BE IT FINALLY RESOLVED, that the Department of Public Works Parks Division 2010
31 Budget be amended as follows:
32

	<u>Budget</u>	<u>Increase/(Decrease)</u>	<u>Amended Budget</u>
33			
34	<u>Source of Funds:</u>		
35	41-4592-4788-42200	2,035	2,027
36	State Aid		4,062
37	<u>Use of Funds:</u>		
38	41-4592-4788-69999	2,035	2,027
39	Non-Converted Expense		4,062

10-9B-145

**APPLICATION AND ACCEPTANCE OF WISCONSIN DEPARTMENT OF
NATURAL RESOURCES COUNTY FISH AND GAME PROJECT GRANT
FUNDS**

PAGE 2

Respectfully submitted,

PUBLIC WORKS COMMITTEE

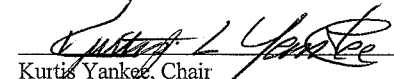
Kurtis Yankee, Chair

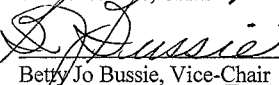
Betty Jo Bussie, Vice-Chair

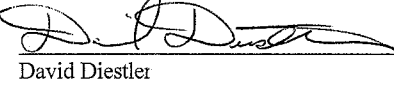

Eva Arnold

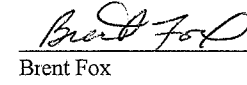
David Diestler

Brent Fox

Finance Committee Endorsement:

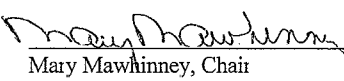
Reviewed and approved on a vote of 5-0

 9-16-10
Mary Mawhinney, Chair Date

FISCAL NOTE:

This resolution authorizes the acceptance and expenditure of \$2,027 in State Aid for the Magnolia Bluff Park Restoration Project. The local match is provided by volunteer labor and contributions of equipment and supplies.

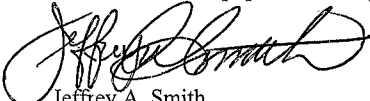
Jeffrey A. Smith
Finance Director

LEGAL NOTE:

The County Board is authorized to accept grant funds pursuant to sec. 59.52(19), Wis. Stats. The authority to accept grant funds pursuant to sec. 59.52(19), Wis. Stats., necessarily implies the authority to make application for such funds.

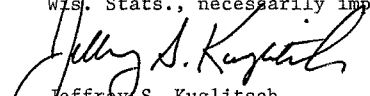
Jeffrey S. Kuglitsch
Corporation Counsel

ADMINISTRATIVE NOTE:

Recommended.

Craig Knutson
County Administrator

- EXECUTIVE SUMMARY -
**APPLICATION AND ACCEPTANCE OF WISCONSIN DEPARTMENT OF NATURAL
RESOURCES
COUNTY FISH AND GAME PROJECT GRANT FUNDS**

Each Wisconsin County is allocated a certain amount of money annually to fund small projects on a 50/50 match basis. Rock County applied for the maximum of \$2,027 in 2006 for work at Magnolia Bluff Park. The grant was applied for, awarded, and extensions were given by the Department of Natural Resources.

The Parks and Highway Divisions through time and materials, as well as other community resources have supplied the required 50% in-kind match.

The Department of Natural Resources funds will be used to build a pathway around the restoration project in order to avoid unnecessary disturbance of the restoration area.

Supplies for the pathway will be purchased with the funds and volunteers will provide the labor. The steering committee and volunteers at Magnolia Bluff Park have been instrumental in these restoration efforts.

Respectfully submitted by,



Lori Williams, Director
Rock County Parks

RESOLUTION NO. 10-9B-146

AGENDA NO. 12.B.

SUBMITTED BY: FINANCE COMMITTEE
DATE: SEP 16 2010

INITIATED: FINANCE DIRECTOR

WHEREAS, THE FINANCE COMMITTEE HAS EXAMINED THE FOLLOWING BILLS OVER \$10,000 AS REQUIRED BY COUNTY RD. RULE H.(3), AND FOUND THEM TO BE PROPER AND WITHIN BUDGET.

NOW THEREFORE BE IT RESOLVED, THE ROCK COUNTY BOARD OF SUPERVISORS AT ITS REGULAR MEETING ON SEP 23 2010, APPROVES PAYMENT AND AUTHORIZES AND DIRECTS THE COUNTY CLERK AND COUNTY TREASURER TO PAY THE SAME.

Vendor Name	Fund Name	Department Name	Program Name	Amount	Claim Amount
CESA 2	GENERAL FUND	SHERIFF	CORR.FACILITY 107041	21,214.96	21,214.96
DELL MARKETING LP	ISF-CS	INFORMATION T	INFORMATION T XF288FFH8	41,495.09	41,495.09
CLAIMS IN THE AMOUNT OF	62,710.05				

HAVE BEEN APPROVED AND CHECKED BY THE GOVERNING COMMITTEES.

RESPECTFULLY SUBMITTED,

FINANCE COMMITTEE

May Mawhorne

P. Kragt

D. J. [Signature]

Mar Bean

Russ Goguly

LEGAL NOTE:

THE COUNTY BOARD RULE CITED REQUIRES THE COUNTY BOARD TO EXAMINE AND SETTLE ALL CLAIMS OVER \$10,000.00

Jeffrey S. Kuglitsch

JEFFREY S. KUGLITSCH
CORPORATION COUNSEL

FISCAL NOTE

ABOVE LISTED CLAIMS ARE FULLY FUNDED.

Jeffrey [Signature]

JEFFREY S. KUGLITSCH
FINANCE DIRECTOR

ADMINISTRATIVE NOTE

RECOMMENDED

Craig Knutson

CRAIG KNUTSON
COUNTY ADMINISTRATOR

10-9B-146

PURCHASE ORDER NUMBER P1000252 PEID 042854

PRE-APPROVED ENCUMBRANCE AMENDMENT FORM

This form must be used when adding funds to or changing an account number of a previously approved encumbrance. Please complete this form and send to your governing committee for approval. The Encumbrance and Purchase Order will be updated upon approval of all necessary committees and County Board (if amendment is over \$10,000).

DEPARTMENT DD Board

COMMITTEE Rock Co. DD Board

VENDOR NAME Secured Living

ACCOUNT NUMBER 33-3310-0000-62604

FUNDS DESCRIPTION CIP IB

AMOUNT OF INCREASE \$ 33,754

INCREASE FROM \$ 344,035 TO \$ 377,789

ACCOUNT BALANCE AVAILABLE \$ 2,657,670 ⁸³⁵¹⁰ ₈₀

REASON FOR AMENDMENT Increase in care rate for one current client.

10-9B-147

APPROVALS

GOVERNING COMMITTEE Marilyn Jensen 9-8-2010
Chair Date

FINANCE COMMITTEE Mary Mawhenny 9-16-10
(if over \$10,000) Chair Date

COUNTY BOARD _____
(if over \$10,000) Resolution # Adoption Date

WHITE - COMMITTEE
YELLOW - PURCHASING
PINK - DEPARTMENT

PURCHASE ORDER NUMBER P1000279 PEID 047496

PRE-APPROVED ENCUMBRANCE AMENDMENT FORM

This form must be used when adding funds to or changing an account number of a previously approved encumbrance. Please complete this form and send to your governing committee for approval. The Encumbrance and Purchase Order will be updated upon approval of all necessary committees and County Board (if amendment is over \$10,000).

DEPARTMENT Human Services

COMMITTEE Human Services

VENDOR NAME Running Rebels

ACCOUNT NUMBER 36-3646-0000-62119 #88,535
36-3654-0000-64604 #25,201

FUNDS DESCRIPTION JJS-Other Contracted Services
YA Sub Care-Program Expense

AMOUNT OF INCREASE \$ 113,736

INCREASE FROM \$ 37,912 TO \$ 151,648

ACCOUNT BALANCE AVAILABLE \$ 36-3646-0000-62119 #153,213
36-3654-0000-64604 #619,726 6/26/10

REASON FOR AMENDMENT extension of contract 08-60/173
based on evaluation results

APPROVALS

GOVERNING COMMITTEE /s/ Brian Knudson 7/14/10
Chair Date

FINANCE COMMITTEE [Signature] 9-16-10
(if over \$10,000) Chair Date

COUNTY BOARD _____
(if over \$10,000) Resolution # Adoption Date

WHITE - COMMITTEE
YELLOW - PURCHASING
PINK - DEPARTMENT

**RESOLUTION
ROCK COUNTY BOARD OF SUPERVISORS**

The General Services Committee
INITIATED BY



Robert Leu
DRAFTED BY

The General Services Committee
SUBMITTED BY

August 30, 2010
DATE DRAFTED

**Awarding Contract for Skylight/Masonry Wall Replacement and Tuck-Pointing at
the Wells Cultural Center on the UW-Rock Campus**

- 1 **WHEREAS**, the Wells Cultural Center on the UW-Rock Campus was constructed in 1980; and,
- 2
- 3 **WHEREAS**, due to leakage and deterioration of the skylights and masonry wall along the north side of
- 4 the building, replacement and reconstruction is necessary; and,
- 5
- 6 **WHEREAS**, specifications were prepared, and bids solicited, with the bid results attached.
- 7
- 8 **NOW, THEREFORE, BE IT RESOLVED** by the Rock County Board of Supervisors duly assembled
- 9 this _____ day of _____, 2010, that a Contract for skylight/masonry wall
- 10 replacement and tuck-pointing on the Cultural Center at the UW-Rock Campus be awarded to the lowest
- 11 responsible and responsive bidder, Gilbank Construction, Inc. of Clinton, WI, in the amount of \$193,200;
- 12 and,
- 13
- 14 **BE IT FURTHER RESOLVED**, that a project contingency of \$20,000 be established to cover any
- 15 change orders authorized by the General Services Committee; and,
- 16
- 17 **BE IT FURTHER RESOLVED**, that payments be made to the vendor upon approval of the General
- 18 Services Committee.

10-9B-148

Respectfully submitted,

General Services Committee:

Phillip Owens, Chair

Henry Brill, Vice Chair

Ronald Combs

Jason Heidenreich

Mary Mawhinney

Purchasing Procedural Endorsement:

Phillip Owens Date Vote

Awarding Contract for Skylight/Masonry Wall Replacement and Tuck-Pointing at the Wells Cultural Center on the UW-Rock Campus

Page 2

FISCAL NOTE:

As of 7/31/10 there is an unencumbered, unexpended balance of \$957,763 in the UW-Rock County Expansion Project, A/C 18-1843-0000-67200.



Jeffrey A. Smith
Finance Director

LEGAL NOTE:

The County Board is authorized to take this action pursuant to secs. 59.01 and 59.51, Wis. Stats. In addition, sec. 59.52(29), Wis. Stats. requires the project to be let to the lowest responsible bidder.

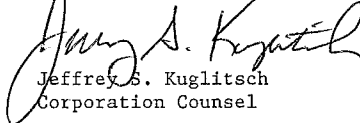

Jeffrey S. Kuglitsch
Corporation Counsel

ADMINISTRATIVE NOTE:

Recommended.



Craig Knutson
County Administrator

Executive Summary

Resolution Awarding Contract for Skylight/Masonry Wall Replacement and Tuck-pointing on the Wells Cultural Center at UW-Rock County

The Wells Cultural Center was constructed in 1980. Since it's construction, the skylights and the north art room wall have been a source of problems that have reached the point where replacement is needed. Over the years the skylight glass cracked and leaked due to shifting in the art room wall. The leakage caused the mortar to crumble allowing more water to enter the wall.

The project will involve replacement of the skylights and masonry wall, along with tuck-pointing of adjacent masonry. Skylight systems over the past 30 years have improved greatly, and today are virtually trouble free. The masonry wall is being redesigned to allow the skylight system to move independently from the wall during temperature swings. The wall will be designed to keep moisture from coming in, plus provisions to rid the wall of moisture should any get in.

The resolution awards the contract to Gilbank Construction of Clinton of in the amount of \$193,200.00. Provisions within the specifications will allow the Campus to use the building during construction.

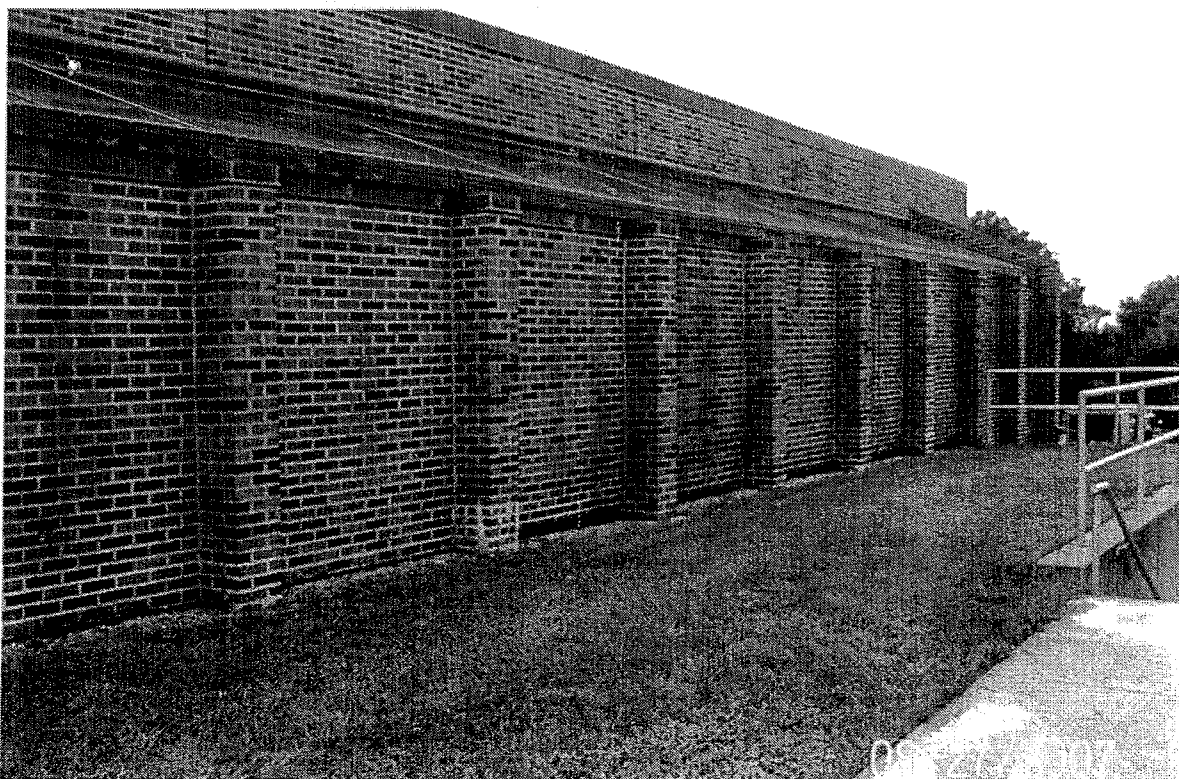

ROCK COUNTY, WISCONSIN
FINANCE DIRECTOR

ORIGINAL

PURCHASING DIVISION
FAX (608) 757-5539
PHONE (608) 757-5517



PROJECT NUMBER #2010-36
PROJECT NAME WELLS CULTURAL CENTER SKYLIGHT AND MASONRY WALL REPLACEMENT AND TUCKPOINTING
BID DUE DATE AUGUST 30, 2010
DEPARTMENT GENERAL SERVICES – UW ROCK COUNTY CAMPUS

	GILBANK CONSTRUCTION CLINTON WI	KLOBUCAR CONSTRUCTION BELOIT WI	PAULSON KIMBALL JANESVILLE WI
BASE BID	\$193,200.00	\$214,000.00	\$249,593.00
BID BOND	YES	YES	YES
ADDENDUM	YES	YES	YES
START DATE	11/1/10	9/20/10	9/13/10
COMPLETION DATE	12/31/10	5/31/11	5/1/11
ALTERNATE BID			SEE ATTACHED
BID CLARIFICATION		SEE ATTACHED	SEE ATTACHED

This Invitation to Bid was advertised in the Janesville Gazette and on the Internet. Twenty-three additional vendors were solicited that did not respond. One vendor submitted a "no bid".

PREPARED BY: Jodi L Miller
PURCHASING MANAGER

DEPARTMENT HEAD RECOMMENDATION: Gilbank Construction

Robert Lee SIGNATURE 8/31/10 DATE

GOVERNING COMMITTEE APPROVAL:

CHAIR _____ VOTE _____ DATE _____

PURCHASING PROCEDURAL ENDORSEMENT:

CHAIR _____ VOTE _____ DATE _____

**RESOLUTION
ROCK COUNTY BOARD OF SUPERVISORS**

The General Services Committee
INITIATED BY



Robert Leu
DRAFTED BY

The General Services Committee
SUBMITTED BY

September 14, 2010
DATE DRAFTED

1
2
3
4
5
6
7
8
9
10
11
12
13
14
15
16
17
18
19
20
21

Awarding Contract for Courthouse Parking Structure Caulking and Repair

WHEREAS, the east and west parking ramps were constructed in 1996 and 1998 respectively; and,

WHEREAS, a number of repairs are needed that include, re-caulking to stop the leaks, re-welding of connecting flanges, and concrete patching; and,

WHEREAS, specifications were prepared, and bids solicited, with the bid results attached.

NOW, THEREFORE, BE IT RESOLVED by the Rock County Board of Supervisors duly assembled this _____ day of _____, 2010, that a Contract for Courthouse Parking Structure Repair be awarded to the lowest responsible and responsive bidder, Zander Solutions of Verona,WI, in Total Bid Amount of \$124,907.00; and,

BE IT FURTHER RESOLVED, that a project contingency of \$10,000.00 be established to cover any change orders authorized by the General Services Committee; and,

BE IT FURTHER RESOLVED, that payments be made to the vendor upon approval of the General Services Committee.

Respectfully submitted,
General Services Committee:

Phillip Owens, Chair

Henry Brill, Vice Chair

Ronald Combs

Jason Heidenreich

Mary Mawhinney

Purchasing Procedural Endorsement:

Phillip Owens Date Vote

10-9B-149

Awarding Contract for Courthouse Parking Structure Caulking and Repair
Page 2

FISCAL NOTE:

As of August 31, 2010 there is an unencumbered, unexpended balance of \$274,272 in the Courthouse Facility Capital Projects, A/C 18-1842-0000-67200.

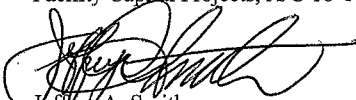

Jeffrey A. Smith
Finance Director

LEGAL NOTE:

The County Board is authorized to take this action pursuant to secs. 59.01 and 59.51, Wis. Stats. In addition, sec. 59.52(29), Wis. Stats. requires the project to be let to the lowest responsible bidder.

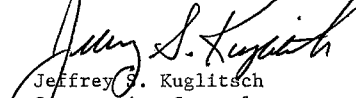

Jeffrey S. Kuglitsch
Corporation Counsel

ADMINISTRATIVE NOTE:

Recommended.



Craig Knutson
County Administrator

Executive Summary

Courthouse Parking Ramp Caulking and Repair Resolution

The Courthouse parking ramps were built when the Courthouse expansion took place starting with the east ramp in 1996.

The ramps were built using precast/prestressed concrete, cast in a factory and assembled on-site. Once on site, the pieces were connected by welded flange plates followed by caulking of the joints. This design, and cast-in-place concrete ramps, are the most commonly used types of structures found.

Unlike buildings, parking structures are unique. They deteriorate much faster, and require more and more maintenance as time passes. De-icing salt, freeze thaw cycles, extreme heat, and the movement of cars cause decks to deteriorate much like bridges do over time. Our ramps are no exception. The caulk joints are breaking their bond, some of the welded flanges have let loose, and the concrete has cracked or spalled in places. Left un-attended, the conditions will only get worse as more salt and water enter the structure, and the freeze/thaw cycles continue.

Prior to bidding out the repairs, Arnold and O'Sheridan Engineers was hired to first inspect the ramps, and then prepare specifications for the repairs. Three bids were received with the low bid coming from Zander Solutions of Verona Wisconsin at \$124,907.00. Work would begin on 10/11 and would be completed by 11/10/2010.

ROCK COUNTY, WISCONSIN
FINANCE DIRECTOR

 ORIGINAL

PURCHASING DIVISION
FAX (608) 757-5539
PHONE (608) 757-5517



PROJECT NUMBER 2010-40
PROJECT NAME PARKING STRUCTURE REPAIRS
BID DUE DATE SEPTEMBER 14, 2010 – 1:30 P.M.
DEPARTMENT GENERAL SERVICES

	ZANDER SOLUTIONS VERONA WI	RAM CONSTRUCTION LITTLE CANADA MN	GILBANK CONSTRUCTION CLINTON WI
BID BOND RECEIVED	YES	YES	YES
BASE BID	\$ 100,021.00	\$ 93,950.00	\$ 120,631.50
ALTERNATE A	7,888.00	10,200.00	13,821.00
ALTERNATE B	1,698.00	3,000.00	4,500.00
ALTERNATE C	15,300.00	24,000.00	15,000.00
TOTAL BID	\$ 124,907.00	\$ 131,150.00	\$ 153,952.50
START DATE	10/11/2010	10/4/2010	NOT LISTED
COMPLETION DATE	11/10/2010	11/11/2010	NOT LISTED

The Invitation to Bid was advertised in the Janesville Gazette and on the Internet. Twenty-three additional vendors were solicited that did not respond. One vendor submitted a "No Bid" and one vendor submitted a non-responsive bid because they did not submit a Bid Bond with their Bid.

- ALTERNATE A - Replacement of perimeter joint sealant
- ALTERNATE B - Repair topside slab cracks
- ALTERNATE C - Replacement of pour strip concrete

PREPARED BY: JODI MILLIS, PURCHASING MANAGER

DEPARTMENT HEAD RECOMMENDATION: Zander Solutions

Robert Lew
SIGNATURE

9/14/10
DATE

GOVERNING COMMITTEE APPROVAL:

CHAIR _____ VOTE _____ DATE _____

PURCHASING PROCEDURAL ENDORSEMENT:

CHAIR _____ VOTE _____ DATE _____

RESOLUTION

ROCK COUNTY BOARD OF SUPERVISORS

Public Works Committee
INITIATED BY



Lori Williams, Parks Director
DRAFTED BY

Public Works Committee
SUBMITTED BY

August 3, 2010
DATE DRAFTED

AGREEMENTS BY AND BETWEEN THE WISCONSIN DEPARTMENT OF TRANSPORTATION AND ROCK COUNTY FOR THE CONSTRUCTION AND MAINTENANCE OF BICYCLE/PEDESTRIAN PATH WITHIN THE RIGHTS-OF-WAY OF STATE HIGHWAY 26 IN ROCK COUNTY

- 1 WHEREAS the State and County have agreed to the development of a Bicycle/Pedestrian path that
- 2 initially contains three sections; and,
- 3
- 4 WHEREAS, Section 1 Rock County path runs along the west side of State Highway 26 starting at
- 5 Storrs Lake Road and extending northerly approximately 4.9 miles to the Rock County line where it
- 6 connects to the existing Glacial River Trail in Jefferson County; and,
- 7
- 8 WHEREAS, Section 2 Rock County path runs along the east side of State Highway 26 starting at
- 9 Town Line Road extending northerly approximately 1.5 miles to Milton City Limits south of
- 10 Highway 59; and,
- 11
- 12 WHEREAS, Section 3 runs along the east side of State Highway 26 starting at Town Hall Road
- 13 and extending northerly 0.5 miles to Town Line Road; and,
- 14
- 15 WHEREAS, the Cities of Janesville and Milton have agreed each to take over the maintenance of
- 16 sections 2 and 3 as their respective municipalities grow into those areas; and,
- 17
- 18 WHEREAS, within said limits the initial construction of the path and appurtenances will be
- 19 financed and completed by the State in cooperation with the County; and,
- 20
- 21 WHEREAS, Wisc. Stat. Sec. 66.0301 authorizes municipalities, including the County and the
- 22 State, to contract with one another for the receipt or furnishing of services or the joint exercise of
- 23 any power or duty required or authorized by law; and,
- 24
- 25 WHEREAS, State Statute 66.0301, (2) specifically authorizes municipalities to enter into
- 26 intergovernmental cooperation agreements for any purpose consistent with other statutory
- 27 provisions for the respective municipalities
- 28
- 29 NOW, THEREFORE, BE IT RESOLVED, that the Rock County Board of Supervisors on this
- 30 _____ day of _____, 2010, hereby approves Intergovernmental Agreements
- 31 with the Wisconsin Department of Transportation for the construction and maintenance of the
- 32 Bicycle/Pedestrian Path within the Rights-Of-Way of State Highway 26 in Rock County.

10-9B-150

RESPECTFULLY SUBMITTED:

PUBLIC WORKS COMMITTEE

Kurtis L. Yankee
Kurtis L. Yankee, Chair

Betty Jo Bussie
Betty Jo Bussie, Vice Chair

Eva Arnold
Eva Arnold

David Diestler
David Diestler

Brent Fox
Brent Fox

Agreements by and Between the Wisconsin Department of Transportation and Rock County for the Construction and Maintenance of Bicycle/Pedestrian Path Within the Rights-of-Way of State Highway 26 in Rock County

Page 2

FISCAL NOTE:

As detailed in the Executive Summary the State would be responsible for the construction cost of the proposed trail. Upon completion, expected by 2013 or 2014, the County would be responsible for maintaining the trail at an initial estimated cost of \$400 per mile. Approximately 6.9 miles of the trail maintenance would be the County's responsibility under the existing proposal.



Jeffrey A. Smith
Finance Director

LEGAL NOTE:

County Board is authorized to take this action pursuant to §59.01, 59.51 and 66.0301, Wis. Stats.

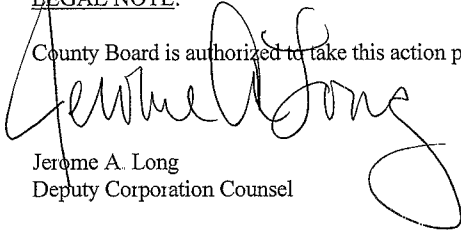

Jerome A. Long
Deputy Corporation Counsel

ADMINISTRATIVE NOTE:

Recommended.



Craig Knutson
County Administrator

- EXECUTIVE SUMMARY -

APPROVING THE AGREEMENTS BY AND BETWEEN THE WISCONSIN DEPARTMENT
OF TRANSPORTATION AND ROCK COUNTY FOR THE CONSTRUCTION AND
MAINTENANCE OF THE BICYCLE/PEDESTRIAN PATH WITHIN THE RIGHTS-OF WAY-
OF STATE HIGHWAY 26 IN ROCK COUNTY

In conjunction with the Highway 26 Bypass Project, the State Department of Transportation (DOT) is planning to construct a paved 40-mile bike/pedestrian pathway in the highway right-of-way from Janesville to north of Watertown. The DOT is requesting cooperation with other jurisdictions and entities for maintenance of the pathway after construction of the path. Various groups who are collaborating on this project include the Cities of Janesville and Milton; Jefferson, Dodge and Rock Counties; and the Wisconsin DOT and DNR.

Rock County has been asked to accept the pathway section from Storrs Lake Road north to County Line Road. This segment is approximately 5 miles long. The State plans to purchase the right-of-way and fund construction at no initial cost to Rock County. If total project costs come in over budgeted amounts, the State will work with Rock County to modify the pathway project to fit within budget parameters.

After construction is complete, Rock County would assume pathway maintenance for a 20-year timeframe. Maintenance expectation of the State is mainly mowing and litter cleanup. The estimated cost is \$400 per mile per year initially, and up to \$700 per year long-term as the pathway ages and anticipated crack filling and other maintenance needs arise.

The State is requesting Rock County enter into four separate agreements: the first being for constructing the highway improvement project and the other three being a maintenance agreement for each pathway section, Section 1 Rock County path from Storrs Lake Road extending north to the Rock County Line. Section 2 Rock County path runs along the east side of State Highway 26 starting at Town Line Road extending northerly approximately 1.5 miles to Milton City Limits south of Highway 59. Section 3 runs along the east side of State Highway 26 starting at Town Hall Road and extending northerly 0.5 miles to Town Line Road. The Cities of Janesville and Milton have each agreed to take over the maintenance of sections 2 and 3 as their respective municipalities grow into those areas. Memorandums of understanding will be drafted with both municipalities after the approval of this resolution.

Support of this project will allow the County a recreational and alternative transportation opportunity that we could not afford on our own. It also allows for connectivity of alternate transportation between communities by providing 40 miles of off-road travel from Janesville to Watertown. It also allows us to cooperate with other jurisdictions and entities in offering a significant asset that will enable us to promote the regional trail as a tourism opportunity and attraction by 2014.

Respectfully submitted,



Lori Williams
Parks Director

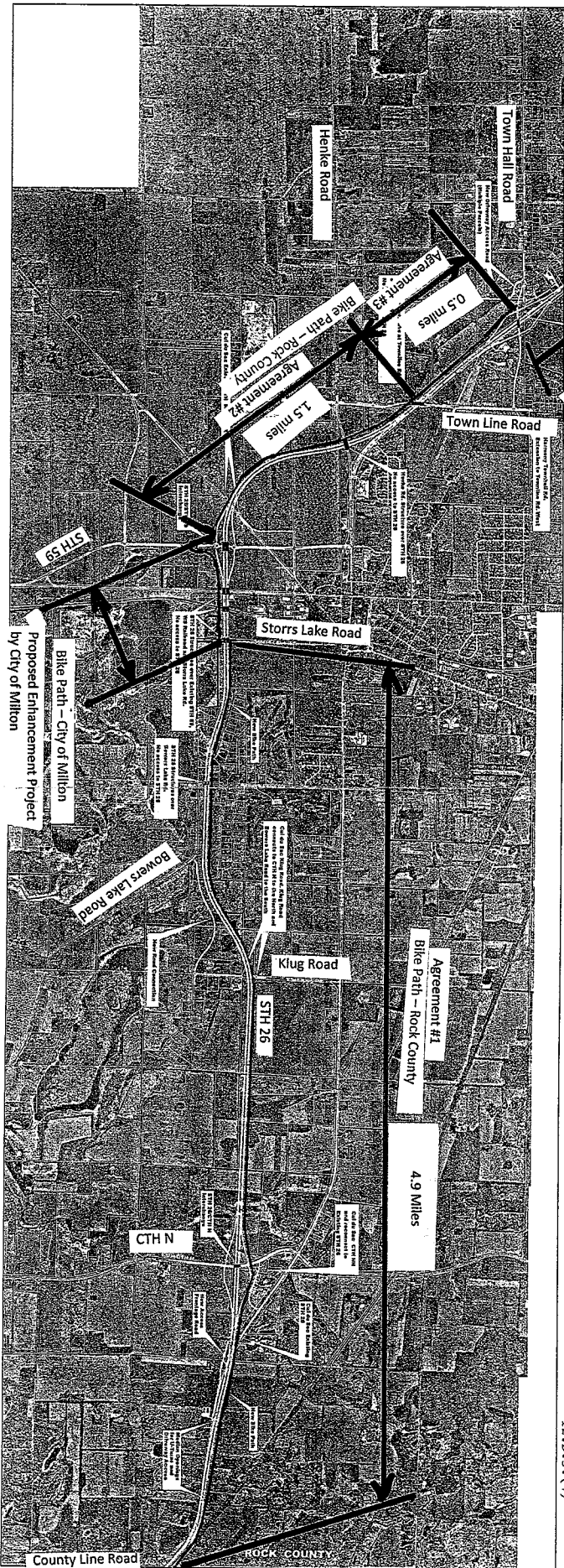

12.D.3.(4)

BICYCLE / PEDESTRIAN PATH

TYPICAL FINISHED SECTION
BICYCLE / PEDESTRIAN PATH

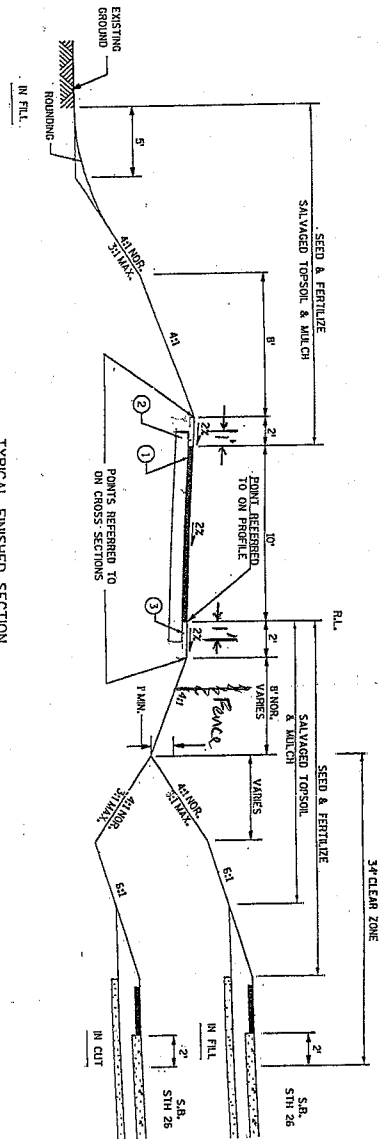

12.D.3.(5)

- LEGEND
- ① 2" RMA PAVEMENT TYPE E-Q-3
 - ② 6" BASE AGGREGATE DENSE 1 1/4-INCH
 - ③ SALVAGED TOPSOIL, MULCH, SEED & FERTILIZER
- ROLED AND COMPACTED**

**RESOLUTION
ROCK COUNTY BOARD OF SUPERVISORS**

David O'Connell
INITIATED BY

David O'Connell
DRAFTED BY

Finance Committee
County Board Staff Committee
SUBMITTED BY



September 10, 2010
DATE DRAFTED

Awarding Contract for Prescription Benefit Manager

- 1 **WHEREAS**, Express Scripts currently administers the County's prescription drug program; and,
- 2
- 3 **WHEREAS**, Willis of Wisconsin, the County's Insurance Consultant, solicited proposals from
- 4 Prescription Benefit Managers (PBMs); and,
- 5
- 6 **WHEREAS**, it was determined that the proposal from Navitus is the most advantageous to the County;
- 7 and,
- 8
- 9 **WHEREAS**, prescription drug coverage is substantially the same under the new contract with Navitus.
- 10
- 11 **NOW, THEREFORE, BE IT RESOLVED**, that the Rock County Board of Supervisors duly
- 12 assembled this _____ day of _____, 2010 does hereby authorize the execution of a
- 13 contract with Navitus for administration of the County's prescription drug program for two years
- 14 beginning January 1, 2011, with annual renewals thereafter.

Respectfully Submitted,

FINANCE COMMITTEE

Mary Mawhinney
Mary Mawhinney, Chair

Sandra Kraft
Sandra Kraft, Vice Chair

Mary Beaver
Mary Beaver

David Diestler
David Diestler

J. Russell Podzilni
J. Russell Podzilni

COUNTY BOARD STAFF COMMITTEE

J. Russell Podzilni
J. Russell Podzilni, Chair

Sandra Kraft
Sandra Kraft, Vice Chair

Eva Arnold
Eva Arnold

Henry Bfill
Henry Bfill

Betty Jo Bussie
Betty Jo Bussie

Ivan Collins
Ivan Collins

Marilynn Jensen
Marilynn Jensen

Louis S. Peer
Louis Peer

Kurtis L. Yankee
Kurtis Yankee

10-9B-151

Awarding Contract for Prescription Benefit Manager

Page 2

LEGAL NOTE:

The County Board is authorized to take this action by Wisconsin Statutes secs. 59.01, 59.51 and 59.52(11) and the Rock County Purchasing Ordinance.

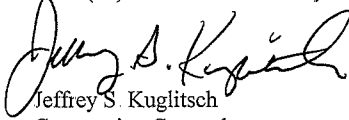

Jeffrey S. Kuglitsch
Corporation Counsel

ADMINISTRATIVE NOTE:

Recommended.

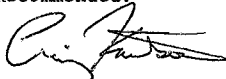

Craig Knutson
County Administrator

FISCAL NOTE:

The Administrative Costs of the PBM is included in the County's actuarially computed health insurance premium. Sufficient funding will be included in the 2011 and 2012 budgets for departmental health insurance premiums.

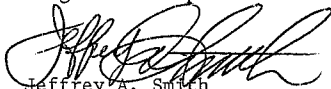

Jeffrey A. Smith
Finance Director

Executive Summary

Awarding Contract for Prescription Benefit Manager

From time to time it is necessary to take service contracts out for bid to assure that the County is receiving the best pricing and service that it can achieve. In furtherance of this effort, Rock County, in conjunction with its health consultant Willis of Wisconsin, issued an RFP for Prescription Benefit Manager (PBM) services. Eight responsive proposals were received and narrowed down by the raters to four competitive proposals. Interviews were conducted with the four finalists.

Navitus was determined to yield the greatest return on our investment of all the proposals submitted. Additionally, it is the opinion of the raters that Navitus is in the strongest position to partner with the County in effectuating cost savings in the future. Lastly, Navitus will contractually bind themselves as part of this agreement by placing \$50,000.00 toward performance guarantees as designated by the County. This is important in that it ascribes financial penalties to the vendor if their performance does not measure up to their promises.

**RESOLUTION
ROCK COUNTY BOARD OF SUPERVISORS**

Sheriff Robert Spoden
INITIATED BY



Diane Michaelis
DRAFTED BY

Public Safety and Justice Committee
SUBMITTED BY

September 7, 2010
DATE DRAFTED

**AUTHORIZING SUBMISSION OF PROJECT SAFE NEIGHBORHOODS
GRANT APPLICATION**

- 1 **WHEREAS**, the Office of Justice Assistance has announced a grant opportunity titled "PSN Western
- 2 District (2010)"; and,
- 3
- 4 **WHEREAS**, Project Safe Neighborhoods (PSN) is a nationwide effort to reduce gun crime and gang
- 5 violence; and,
- 6
- 7 **WHEREAS**, Rock County agencies are eligible to apply for a maximum of \$25,847; and,
- 8
- 9 **WHEREAS**, this is a competitive grant with limited eligibility and with no local match or cost-sharing
- 10 requirement; and,
- 11
- 12 **WHEREAS**, the Sheriff's Office intends to submit a joint application with the Beloit Police Department
- 13 and the Janesville Police Department in the amount of \$25,847; and,
- 14
- 15 **NOW, THEREFORE, BE IT RESOLVED**, that the Rock County Board of Supervisors duly
- 16 assembled this _____ day of _____, 2010, does hereby approve and authorize the
- 17 submission of a Project Safe Neighborhoods Grant application, and the Chair of the Rock County
- 18 Board of Supervisors is hereby authorized to sign all necessary documents on behalf of the County of
- 19 Rock.

10-9B-152

Respectfully submitted,

Public Safety and Justice Committee

Ivan Collins, Chair

Larry Wiedenfeld, Vice Chair

Mary Beaver

Henry Brill

Brian Knudson

AUTHORIZING SUBMISSION OF PROJECT SAFE NEIGHBORHOODS GRANT APPLICATION

Page 2

FISCAL NOTE:

This resolution only authorizes an application for a grant and, therefore, has no fiscal impact at this time. If a grant is awarded a subsequent resolution would be required to accept the grant and amend the budget.



Jeffrey A. Smith
Finance Director

LEGAL NOTE:

The authority to accept grant funds pursuant to sec. 59.52(19), Wis. Stats., necessarily implies the authority to make application for such funds.

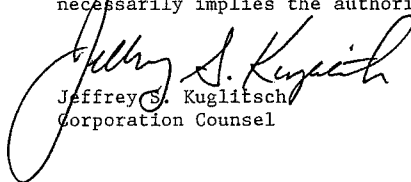

Jeffrey S. Kuglitsch
Corporation Counsel

ADMINISTRATIVE NOTE:

Recommended.



Craig Knutson
County Administrator

Executive Summary
Authorizing Submission of Project Safe Neighborhoods Grant Application

The Office of Justice Assistance has announced a grant opportunity titled "PSN Western District (2010)." Project Safe Neighborhoods (PSN) is a nationwide effort to reduce gun crime and gang violence. Rock County agencies are eligible to apply for a maximum of \$25,847.

This is a competitive grant with limited eligibility. The programs to be funded must be geared toward projects that demonstrate an effort to reduce gang, gun, or violent crime in the Western District of Wisconsin. Projects that are collaborative or projects that have an emphasis on information sharing will receive preference.

The intent of the Sheriff's Office is to submit a joint application with the Beloit Police Department and the Janesville Police Department in the amount of \$25,847. No local match is required.

This resolution authorizes the Sheriff's Office to submit an application for the Project Safe Neighborhoods grant.

**RESOLUTION
ROCK COUNTY BOARD OF SUPERVISORS**

Public Safety & Justice
INITIATED BY



David Sleeter
DRAFTED BY

Public Safety & Justice
SUBMITTED BY

September 9, 2010
DATE DRAFTED

REPLACEMENT OF 911 CENTER BACK-UP TELEPHONE SYSTEM

1 **WHEREAS**, the Rock County 911 Communications Center was designed to coordinate efficient public
2 safety responses for all Rock County citizens 24 hours a day throughout the year; and,
3
4 **WHEREAS**, to accomplish this mission, 911 Communications Center services must be available at all
5 times under any type of conditions; and,
6
7 **WHEREAS**, the telephone system at the 911 Communications Center is a critical component in
8 providing communications services to Rock County citizens at all times; and,
9
10 **WHEREAS**, a back-up telephone system is a 911 industry standard for consolidated communications
11 centers in order to provide continuous telephone services; and,
12
13 **WHEREAS**, the Rock County 911 Communications Center currently has a back-up telephone system in
14 the event that the primary telephone system fails; and,
15
16 **WHEREAS**, the vendor who supports the 911 Center's back-up telephone system has terminated support
17 for this system; and,
18
19 **WHEREAS**, the 911 Center back-up telephone equipment must be fully integrated with the telephone
20 equipment now operating at the 911 Communications Center and the existing County telephone network;
21 and,
22
23 **WHEREAS**, Enterprise Systems Group of Little Chute, Wisconsin can provide a 911 Center back-up
24 telephone system that will fully integrate with the current 911 Center and Rock County telephone
25 network; and,
26
27 **WHEREAS**, the funding necessary for the purchase of the Communications Center back-up site
28 telephone equipment is available in the 2010 budget; and,
29
30 **NOW, THEREFORE, BE IT RESOLVED** by the Rock County Board of Supervisors duly assembled
31 this _____ day of _____, 2010 a contract be awarded to Enterprise Systems Group of
32 Little Chute, Wisconsin in the amount of \$17,180 with the County Board Chair herein authorized to
33 execute the purchase agreements.

10-9B-153

Replacement of 911 Center Back-Up Telephone System

Page 2

Respectfully submitted,

Public Safety and Justice

Ivan Collins, Chair

Larry Wiedenfeld, Vice Chair

Mary Beaver

Hank Brill

Brian Knudson

FISCAL NOTE:

\$384,500 is included in the 911 Communications Center Capital Projects 2010 budget, A/C 23-2415-0000-67171, including the replacement of the back-up center's telephone system. This appropriation is funded by the 2010 Debt Issue.

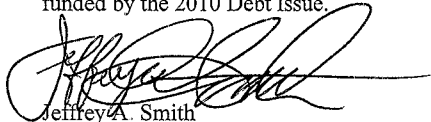
Jeffrey A. Smith
Finance Director

LEGAL NOTE:

The County Board is authorized to take this action pursuant to secs. 59.01 and 59.51, Wis. Stats.

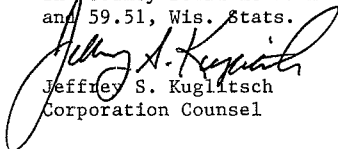
Jeffrey S. Kuglitsch
Corporation Counsel

ADMINISTRATIVE NOTE:

Recommended.

Craig Knutson
County Administrator

EXECUTIVE SUMMARY

The Rock County 911 Communications Center was designed to provide efficient communications services for public safety responses for Rock County citizens 24 hours a day/365 days of the year. To accomplish this mission, it is essential that the 911 Communications Center services be operational under any type of conditions.

One of the most critical components of any 911 Communications Center operations is the continuous availability of telephone services (emergency and non-emergency). The Rock County 911 Communications Center currently has a redundant telephone system in the event that the primary telephone system fails.

The vendor who supports the 911 Center's current back-up telephone system has announced that support for the back-up telephone system has been terminated. Any replacement back-up telephone system must be fully integrated with the existing 911 Center and Rock County telephone networks.

The Rock County Information Technology Department has recommended that a back-up 911 Center telephone system be purchased from Enterprise Systems Group of Little Chute, Wisconsin, at a cost of \$17,180. This recommendation is predicated upon the requirement that the back-up telephone system is capable of full integration into the existing 911 Center and Rock County telephone networks.

Funding to purchase the back-up telephone system for the Rock County 911 Communications Center was included in the 2010 Budget.

RESOLUTION

ROCK COUNTY BOARD OF SUPERVISORS

Lori Williams, Parks Director
INITIATED BY



Lori Williams, Parks Director
DRAFTED BY

Public Works Committee
SUBMITTED BY

September 1, 2010
DATE DRAFTED

**Recognizing Efforts of the Friends of Beckman Mill, Incorporated,
at Beckman Mill County Park on Their 20th Anniversary**

- 1 **WHEREAS**, the Rock County Board of Supervisors entered into a long-term agreement in 1991 with the
- 2 Friends of Beckman Mill, Incorporated, to do historical restoration and development work at Beckman Mill
- 3 County Park; and,
- 4
- 5 **WHEREAS**, the Friends of Beckman Mill are celebrating their 20th anniversary as an organization; and,
- 6
- 7 **WHEREAS**, the Friends of Beckman Mill have restored the historic Howe-Beckman Mill, the cooperage,
- 8 and constructed a creamery, a visitors' center and a barn, as well as reconstructed the spillway (mill pond
- 9 dam) and fish passage on the West Fork of Raccoon Creek; and,
- 10
- 11 **WHEREAS**, the Friends of Beckman Mill have "compounded" grant dollars provided by Rock County and
- 12 have secured and utilized grants from: Wisconsin DNR River Protection Grant, Whitetails Unlimited,
- 13 Ressler Mill Foundation, Beloit Foundation, Janesville Foundation, Kohler Foundation, Harnischfeger, Inc.,
- 14 Lutheran Brotherhood, Questers, Greater Beloit Community Foundation, Ashcraft Foundation, Wisconsin
- 15 Power and Light and the Society for the Preservation of Old Mills; and,
- 16
- 17 **WHEREAS**, the Friends of Beckman Mill make the substantial donation of volunteer labor and donated
- 18 machinery used in carrying forward these efforts, and showcasing the Park as caregivers and docents; and,
- 19
- 20 **WHEREAS**, in 2010, the restored Beckman Mill Park is a one-of-a-kind destination of historical
- 21 significance in Rock County that serves as the host site for numerous annual activities and events.
- 22
- 23 **NOW, THEREFORE, BE IT RESOLVED**, that the Rock County Board of Supervisors duly assembled
- 24 this ____ day of _____, 2010, hereby recognizes the Friends of Beckman Mill on their
- 25 20th anniversary and extends their congratulations and gratitude on the outstanding volunteer work and
- 26 restoration efforts and looks forward to a continued partnership in the future.

10-9B-154

Respectfully submitted,

PUBLIC WORKS COMMITTEE

Kurtis Yankee
Kurtis Yankee, Chair

Betty Jo Bussie
Betty Jo Bussie, Vice-Chair

Eva Arnold
Eva Arnold

David Diestler
David Diestler

Brent Fox
Brent Fox

- Executive Summary -
Commending Efforts of the Friends of Beckman Mill, Incorporated,
at Beckman Mill County Park on Their 20th Anniversary

Rock County started its long-term relationship with the Friends of Beckman Mill, Incorporated, June 1, 1991. The first lease agreement expired in May 2001 and was renewed through 2013.

The Friends of Beckman Mill, Incorporated, have vigorously pursued other grant funding sources and have successfully been awarded well over \$100,000 in grant funds from various organizations. Such organizations have included Society for the Preservation of Old Mills (SPOOM), Wisconsin Power & Light, Ashcraft Foundation, Greater Beloit Community Foundation, Questers, Lutheran Brotherhood, Harnischfeger, Inc., Kohler Foundation, Janesville Foundation, Beloit Foundation, Ressler Mill Foundation, Wisconsin DNR, and Whitetails Unlimited.

The Friends have restored the Howe-Beckman Mill, the cooperage, and constructed a creamery, a visitors' center, and a barn and reconstructed the spillway (mill pond dam) and fish passage on the West Fork of Raccoon Creek.

Each year, the Friends of Beckman Mill, Incorporated, have also held numerous fund raising activities bringing many people to visit this park. They also give tours of the Park and do many hours of volunteer maintenance of the mill, buildings and grounds.

We look forward to a continued successful partnership with a truly exemplary and outstanding group of volunteers.

Respectfully submitted,



Lori Williams
Parks Director

RESOLUTION NO. 10-9B-155

AGENDA NO. 12.H.

**RESOLUTION
ROCK COUNTY BOARD OF SUPERVISORS**

Wayne Gustina
INITIATED BY



Phil Boutwell
DRAFTED BY

EVA Committee
SUBMITTED BY

September 13, 2010
DATE DRAFTED

**Honoring John and Mark Finnegan for Organizing the "VetsRoll" Project for
WW II Veterans**

- 1 **WHEREAS**, John and Mark Finnegan recognized that World War II Veterans are now at advanced ages
- 2 that makes it difficult for them to travel and visit places such as the WW II Memorial in Washington DC,
- 3 which opened in April 2004 to honor their service to this county; and,
- 4
- 5 **WHEREAS**, John and Mark also realized that unless they took it upon themselves to do something,
- 6 many state line World War II Veterans would not have the chance to make that trip in their lifetime; and,
- 7
- 8 **WHEREAS**, John and Mark came up with the concept of a project and called it "VetsRoll," which had
- 9 the mission to sponsor, fund raise, find volunteers, and solicit state line World War II Veterans for an all
- 10 expense paid trip to Washington DC to visit sites including the WW II Memorial; and,
- 11
- 12 **WHEREAS**, they tirelessly promoted the project in the spring of 2010 and on May 17th "VetsRoll" set-
- 13 off with over 100 Veterans in a caravan of 3 buses and 10 motor homes on a four day round trip to
- 14 Washington, DC; and,
- 15
- 16 **WHEREAS**, Mark Finnegan, who drove one of the motor homes on the 1,500-mile round trip, said the
- 17 experience was wonderful for the Veterans.
- 18
- 19 **NOW, THEREFORE, BE IT RESOLVED** by the Rock County Board of Supervisors duly assembled
- 20 this ____ day of _____, 2010 does hereby honor John and Mark Finnegan for taking the
- 21 initiative and providing a wonderful experience for World War II Veterans who deserve all the proper
- 22 respect and gratitude that can possibly be given to them.

10-9B-155

Respectfully submitted,

EDUCATION, VETERANS & AGING COMMITTEE

Terry Thomas, Chair

Marvin Wopat, Vice Chair

Wayne Gustina

David Innis

Katie Kuznacic

MEMORANDUM

DATE: September 9, 2010
TO: Rock County Board of Supervisors
FROM: Phil Boutwell, Assistant to the County Administrator
SUBJECT: WCA Resolutions

This year, the WCA Convention will be held in Milwaukee from September 26th to September 28th. The WCA Resolutions will be considered for adoption during the business meeting on September 27th.

Rule V-D.(8) of the Rock County Board Rules of Procedure directs an Assistant to the County Administrator to review the resolutions to be considered at the Convention, and to select the resolutions having the greatest impact on Rock County. I have selected six of the thirty-one resolutions that are up for consideration in 2010.

The County Board Staff Committee will discuss the resolutions at its September 14th meeting. The attached resolutions are forwarded for your review. The "Review of WCA Resolutions" will be placed as an item on the September 23rd County Board Agenda.

According to Rule V-D.(8), the Board shall recommend to the County's voting delegate how to vote on the attached resolutions. Thank you for your consideration.

Attachments

Wisconsin Counties Association

2010 Conference Resolution 5

Offered for consideration this 27th Day of September, 2010 by

Dodge County

Relating to

Opposing Changes that Were Made to the Prevailing Wage Laws

WHEREAS, the Wisconsin Legislature and the Governor made extensive changes to prevailing wage laws (Sections 66.0903 and 103.49, Wis. Stats.), effective January 1, 2010, by enactment of the state budget, 2009 Wisconsin Act 28; and

WHEREAS, under prior law the prevailing wage requirements applied only to multiple-trade public works projects over \$234,000 and single-trade public works projects over \$48,000; and

WHEREAS, under current law prevailing wage requirements apply to public works projects of \$25,000 or more; and

WHEREAS, under prior law the prevailing wage requirements did not apply to private projects that received public financing; and

WHEREAS, under current law the prevailing wage requirements apply to private projects that receive public funding; and

WHEREAS, the reduction in the prevailing wage requirements threshold to \$25,000 will increase the cost of many small public works projects previously exempted from the prevailing wage requirements; and

WHEREAS, the increased costs to pay prevailing wages on all public works projects which cost \$25,000 or more will force counties and other local governments to either reduce the number and/or size of public works projects or raise taxes to meet the increased costs, which will further burden property taxpayers; and

Page 2
2010 Resolution 5

WHEREAS, the changes that were made to prevailing wage laws effective January 1, 2010, will add to the cost of projects in Dodge County at a time when Dodge County is operating under numerous financial constraints including levy limits and tax rate limits.

NOW, THEREFORE, BE IT RESOLVED that the Wisconsin Counties Association, in conference assembled, does hereby urge the Wisconsin Legislature and the Governor to ~~rescind~~ modify the changes that were made to prevailing wage laws (Sections 66.0903 and 103.49, Wis. Stats.) effective January 1, 2010, by enactment of the state budget, 2009 Wisconsin Act 28, to enable local governments to operate in a more cost-effective manner.

STEERING COMMITTEE RECOMMENDATION TO THE RESOLUTIONS COMMITTEE:

County Organization and Personnel: Adopt.

Transportation and Public Works: Move to amend the resolved clause to strike the word "rescind" and replace with "modify" and add the following after "2009 Wisconsin Act 28:" to enable local governments to operate in a more cost-effective manner. Adopt as amended.

RESOLUTIONS COMMITTEE ACTION: Motion by HELWIG, second by PLIML, to adopt. Motion by RICE, second by BILLINGS, to amend the resolved clause to strike the word "rescind" and replace with "modify" and add the following after "2009 Wisconsin Act 28:" to enable local governments to operate in a more cost-effective manner. Motion carried. Resolution adopted as amended.

RESOLUTIONS COMMITTEE RECOMMENDATION: Adopt as amended by the Resolutions Committee.

2010 CONFERENCE ACTION:

Caption:

Support legislation modifying the changes that were made to prevailing wage laws (Sections 66.0903 and 103.49, Wis. Stats.) effective January 1, 2010, by enactment of the state budget, 2009 Wisconsin Act 28, to enable local governments to operate in a more cost-effective manner.

Wisconsin Counties Association

2010 Conference Resolution 6

Offered for consideration this 27th Day of September, 2010 by

Washington County

Relating to

Supporting Wisconsin Legislation Changing the Process for Setting Elected County Officials' Compensation

WHEREAS, the Wisconsin Constitution provides for the election of certain county officials by county residents, namely, the County Clerk, Treasurer, Sheriff, Register of Deeds, Clerk of Circuit Court, District Attorney and Coroner ("county elected officials"); and

WHEREAS, prior to 2005, the term of office for these county elected officials was two years; and

WHEREAS, in 2005, by the adoption of a constitutional amendment, the term of office was changed to four years, and was phased in beginning with the 2006 gubernatorial election electing Sheriffs, Clerks of Circuit Court and Coroners to four year terms and with the 2008 presidential election electing District Attorneys, Registers of Deeds, Treasurers and County Clerks to four year terms; and

WHEREAS, current law (s. 59.22, Wis. Stats.) requires the county board to establish the total annual compensation for services to be paid to the officer, for officers paid in whole or in part by the county treasury, which compensation cannot be modified during the officer's term and shall remain for ensuing terms unless changed by the board; and

WHEREAS, counties establish operating budgets annually, operate on a fiscal calendar year and are required to comply with state mandated tax levy limits; and

WHEREAS, historically, the county board has struggled with setting compensation for county elected officials, due to changing and uncertain economic conditions, operating budgets being considered and approved annually and the various state levy limit mandates imposed on counties; and

Page 2
2010 Resolution 6

WHEREAS, the transition to four year terms for county elected officials has made setting compensation even more difficult.

NOW, THEREFORE, BE IT RESOLVED that the Wisconsin Counties Association, in conference assembled, does hereby urge that legislation be introduced to allow county boards the option of setting county elected officials' compensation annually, in conjunction with its annual operating budget, and consistent with the process for establishing the compensation for the general county employees, ~~but not allowing for the lowering of the annual compensation during the term and not based on performance of the county elected offices which performance is to be reserved to the judgment of the electorate.~~

STEERING COMMITTEE RECOMMENDATION TO THE RESOLUTIONS COMMITTEE:

Amend the resolved clause to delete the following language: “, but not allowing for the lowering of the annual compensation during the term and not based on performance of the county elected offices which performance is to be reserved to the judgment of the electorate.” Adopt as amended.

RESOLUTIONS COMMITTEE ACTION: Motion by WIDENER, second by KRUEGER, to adopt. Motion by PODZILNI, second by CLARK, to amend the resolved clause to specify that during the four-year term, counties can set salaries for two years, after which counties can re-evaluate, but not lower, salaries. Motion withdrawn. Motion by RASMUSSEN, second by SWOBODA, to amend the resolved clause to delete the following language: “, but not allowing for the lowering of the annual compensation during the term and not based on performance of the county elected offices which performance is to be reserved to the judgment of the electorate.” Motion carried. Motion by SCHROEDER, second by PODZILNI, to strike the word “compensation” from the resolved clause and replace with “salary.” Motion failed. Resolution adopted as amended.

RESOLUTIONS COMMITTEE RECOMMENDATION: Adopt as amended by the Resolutions Committee.

2010 CONFERENCE ACTION:

Caption:

Support legislation allowing county boards the option of setting county elected officials' compensation annually, in conjunction with its annual operating budget, and consistent with the process for establishing the compensation for the general county employees.

Wisconsin Counties Association

2010 Conference Resolution 11

Offered for consideration this 27th Day of September, 2010 by

Rock County

Relating to

Requesting State Law Change Allowing Counties the Use of the Design-Build Construction Method

WHEREAS, under Chapter 59.52(29), Wisconsin counties are required to engage in a competitive bidding process on public work construction projects greater than \$25,000; and

WHEREAS, the State of Wisconsin has recognized the advantages of the design-build method and authorizes that process to be followed for state-controlled building projects; and

WHEREAS, under the design-build construction method, counties would contract with a single entity to provide both the design and construction of a public work project; and

WHEREAS, in addition to a single source of responsibility, other advantages of design-build include enhanced creativity, guaranteed costs, faster project completion, improved risk management, fewer change orders and less administrative burden.

NOW, THEREFORE, BE IT RESOLVED that the Wisconsin Counties Association, in conference assembled, does hereby support legislation authorizing counties to utilize the design-build option.

STEERING COMMITTEE RECOMMENDATION TO THE RESOLUTIONS COMMITTEE:

Adopt.

RESOLUTIONS COMMITTEE ACTION: Motion by PODZILNI, second by STOFFEL, to adopt. Motion carried.

RESOLUTIONS COMMITTEE RECOMMENDATION: Adopt.

Page 2
2010 Resolution 11

2010 CONFERENCE ACTION:

Caption:

Support legislation authorizing counties to use a design and build method of construction.

COUNTY ORGANIZATION AND PERSONNEL

Wisconsin Counties Association

2010 Conference Resolution 16

Offered for consideration this 27th Day of September, 2010 by

Rock County

Relating to

Opposing Legislative Initiative to Establish State Oversight of Public Self-Insured Health Plans

WHEREAS, Rock County is self insured for its health plan that provides good benefits for its employees at less cost than if it were to pay premiums to an insurance company for purchased coverage; and

WHEREAS, Senate Bill 466 creates statutory authority for the Office of the Commissioner of Insurance to oversee self-funded health plans that serve public employees; and

WHEREAS, the proposed legislation adds unneeded and burdensome regulation that increases cost and removes any advantages over purchased coverage that Rock County presently enjoys through its self-insured health plan; and

WHEREAS, Rock County's self-insured plan thrives because of our active role in administering benefits and managing charges levied by health care providers; and

WHEREAS, Rock County views Senate Bill 466 as a "solution in search of a problem that does not exist" and impinges the County's flexibility and freedom to manage its plan to provide affordable high quality health insurance.

NOW, THEREFORE, BE IT RESOLVED that the Wisconsin Counties Association, in conference assembled, does hereby oppose legislative initiatives such as Senate Bill 466 that establish state oversight of public self-insured health plans.

STEERING COMMITTEE RECOMMENDATION TO THE RESOLUTIONS COMMITTEE:

Adopt.

RESOLUTIONS COMMITTEE ACTION: Motion by PODZILNI, second by HELWIG, to adopt. Motion carried.

Page 2
2010 Resolution 16

RESOLUTIONS COMMITTEE RECOMMENDATION: Adopt.

2010 CONFERENCE ACTION:

Caption:

Oppose legislation providing state oversight of public self-insured health plans.

COUNTY ORGANIZATION AND PERSONNEL

Wisconsin Counties Association

2010 Conference Resolution 24

Offered for consideration this 27th Day of September, 2010 by

Outagamie County

Relating to

Opposing Legislation Creating a Countywide Assessment System

WHEREAS, under current law, there is a two-step process for valuing property in the state for the purpose of levying property taxes; and

WHEREAS, first, local assessors determine the assessed values for individual properties, except for manufacturing property, in each municipality; and

WHEREAS, assessed values are used for apportioning property taxes on tax bills to individual properties within municipalities; and

WHEREAS, second the state Department of Revenue (DOR) estimates the full market or equalized value of all property in each district; and

WHEREAS, equalized values are used to apportion the levies of overlying districts (for example, schools and counties) to the municipalities within them and also to distribute certain state aid; and

WHEREAS, the state values are needed because municipalities assess property at varying percentages of market value; and

WHEREAS, DOR also assesses all manufacturing property within the state; and

WHEREAS, under current law, a county board may vote to create a county assessor system that is responsible for conducting property tax assessments for all non-manufacturing property located within the county; and

WHEREAS, no county currently has such a system; and

WHEREAS, the Department of Revenue is proposing legislation that would:

- Require counties to assume all assessment functions within five years.
- Require annual full valuation, starting with a revaluation of all parcels within three years, and eliminate equalization. The DOR would audit county assessments to ensure that a county's values adhere to state requirements.
- Establish an electronic property assessment system.
- Allow counties to consolidate assessment responsibilities and/or contract with existing municipal assessors to provide assessment services.
- Allow towns, villages and cities to have a voice in all assessment functions including administration, assessment and board review. The board of review would operate at the county level.
- Maintain manufacturing assessment at the state level, but shift the Department's responsibility to certifying, regulating, and auditing the county assessment process.
- Create new standards and licensing for property assessors, including a requirement that those holding the newly-created position of county assessment administrator be certified by the DOR.
- Exempt the cost of county assessment services from the current levy limits. Under the DOR's proposed legislation, municipalities that had been responsible for assessments would not have to reduce their levies by a corresponding amount for the first five years of the new system.

NOW, THEREFORE, BE IT RESOLVED that the Wisconsin Counties Association, in conference assembled, does hereby oppose legislation creating a countywide assessment system which will take local control away from towns, villages and cities, which is the basic principal of local government; and

BE IT FURTHER RESOLVED that the Wisconsin Counties Association acknowledges that the cost of the county assessment system will be at least \$25 per parcel compared to many towns and villages that have less than \$10 per parcel costs and opposes any county property tax increase to implement this proposed change.

STEERING COMMITTEE RECOMMENDATION TO THE RESOLUTIONS COMMITTEE:

Adopt.

RESOLUTIONS COMMITTEE ACTION: Motion by SCHROEDER, second by PLIML, to adopt. Motion carried.

RESOLUTIONS COMMITTEE RECOMMENDATION: Adopt.

Page 3
2010 Resolution 24

2010 CONFERENCE ACTION:

Caption:

Oppose legislation mandating a countywide assessment system.

TAXATION AND FINANCE

Wisconsin Counties Association

2010 Conference Resolution 29

Offered for consideration this 27th Day of September, 2010 by

La Crosse County

Relating to

Supporting Restoring Fairness by Correcting the Disparate Impact of the Tax Rate Limit at a Time of Declining Property Values

WHEREAS, counties are subject to two separate levy constraints, the 3% "levy freeze cap" Wis. Stats. 66.0602 and the "tax levy rate limit" Wis. Stats. 59.605(2); and

WHEREAS, the "levy freeze cap" permits all counties to increase the operating tax levy by up to 3%, and the "tax rate limit" establishes the 1992 operating levy rate for each county as the maximum ceiling, not permitting the county to exceed this 1992 rate unless approved by a referendum; and

WHEREAS, the Operating Levy Tax Rate is a function of the levy divided by the total equalized value, so that in a time of declining property values, some counties will quickly reach the 1992 operating rate limit and would not be able to increase their operating tax levy by the 3% permitted for all counties to meet the rising costs of underfunded mandated programs; and

WHEREAS, La Crosse County has the 15th lowest tax rate and 5th lowest tax levy per capita of all 72 Wisconsin counties and has over \$2.25 million of unused tax levy authority under the levy freeze cap, yet would be unable to increase the operating tax levy by 3% if the total equalized value declines by more than 2%, while other counties with higher tax rates and a higher levy per capita would be permitted to increase their operating levy by up to 3%; and

WHEREAS, using the 3% allowable increase of 66.0602 (1)(d) as the controlling factor to take precedence over the 1992 rate limit, could create a second option to a referendum for a county to exceed the 1992 rate limit, while still restricting the rise in a county tax levy so that all counties would be permitted the same 3% limit.

Page 2
2010 Resolution 29

NOW, THEREFORE, BE IT RESOLVED that the Wisconsin Counties Association, in conference assembled, does hereby support legislation to correct the disparate impact on some Wisconsin counties of the tax rate limit at a time of declining property values by adding the following exception for a county to exceed the 1992 rate limit in addition to the referendum option:

s. 59.605(3) TAX BASE: if a county's allowable levy under s. 66.0602 (1)(d) is greater than the allowable levy under s. 59.605(2) then the county is exempt from the limit under 59.0605(2) in that tax year, and the Department of Revenue shall modify the operating levy rate for subsequent years to this new rate.

STEERING COMMITTEE RECOMMENDATION TO THE RESOLUTIONS COMMITTEE:
Adopt.

RESOLUTIONS COMMITTEE ACTION: Motion by ZELLMER, second by BILLINGS, to adopt. Motion carried.

RESOLUTIONS COMMITTEE RECOMMENDATION: Adopt.

2010 CONFERENCE ACTION:

Captions:

Support legislation creating the following exception for a county to exceed the 1992 rate limit in addition to the referendum option:

s. 59.605(3) TAX BASE: if a county's allowable levy under s. 66.0602 (1)(d) is greater than the allowable levy under s. 59.605(2) then the county is exempt from the limit under 59.0605(2) in that tax year, and the Department of Revenue shall modify the operating levy rate for subsequent years to this new rate.

TAXATION AND FINANCE